

# BASK IN THE TRUE CINEMATIC EXPERIENCE.

## EpiqVision Ultra EH-LS300B

**EPSON**  
EXCEED YOUR VISION

androidtv



 **PT. MANDIRI ARTHA SOLUSI**  
EMPOWERING BUSINESS FORWARD

**Be enthralled by the cinematic experience with Epson's EpiqVision EH-LS300B Laser Projection TV.**

With its whopping 120-inch of solid, vibrant, and bold projections, limitations no longer matter when it comes to the ultra-short-throw EpiqVision Ultra EH-LS300B Laser Projection TV. Mesmerising with every projection, it comes built-in with a powerful Yamaha 2.1ch sound system that brings richer and deeper sounds. Equipped with inbuilt Android TV, it allows you to enjoy endless entertainment right at the comfort of your living room.



**IT'S IN THE DETAILS.**

EpiqVision Ultra



\* Support up to 4K/60Hz 4:2:0.

## A Feast For Your Eyes Immersive, Full-HD, High Contrast Ratio Images

Entrancing projections made possible with EpiqVision Ultra EH-LS300B's laser light source and over 2,500,000:1 contrast ratio. The HDR10 decoding process also ensures a display of high-dynamic images that are pleasing and vivid for your eyes.



## Up to 120-inch Massive, Screenless Display

Redefining your home theatre set-up, the EpiqVision Ultra EH-LS300B, with its ultra-short throw capability of 70cm, projects up to a spectacular 120-inch screen size of crisp and bright images. Fitting right into your space's aesthetic, the compact laser projection TV offers the flexibility to place it anywhere that is convenient for you.

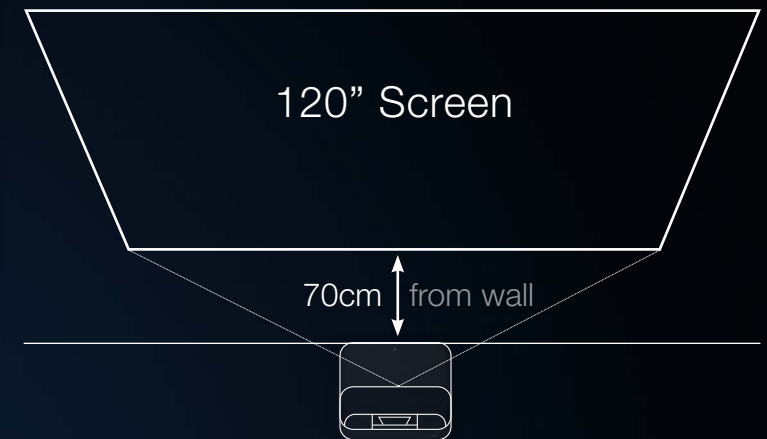

## Alluring Colors and Brightness Projecting Life-like and Natural Images

Featuring the new vivid color mode and scene adaptive gamma correction, the EpiqVision Ultra EH-LS300B can adjust the gamma level of an image automatically, bringing you a perfect picture in every scene. Now, you can enjoy life-like, vibrant, and natural images close to what is seen by the human eyes on the screen.

Scene Adaptive Gamma Correction



In **dark** scene



In **bright** scene

New Vivid Color Mode



**Vivid** (Default)



**Bright Cinema**

## Superior Sound Quality Audiophile 2.1 Speaker System by Yamaha

Elevate your home viewing experience with stunning 3D-surround sound accompanied by clear and powerful bass with the built-in Yamaha 2.1ch sound system. Feel as if you are live at the venue by fine-tuning sounds with different modes for different content. You can also enjoy your music to the fullest by using it as a standalone speaker via Bluetooth.

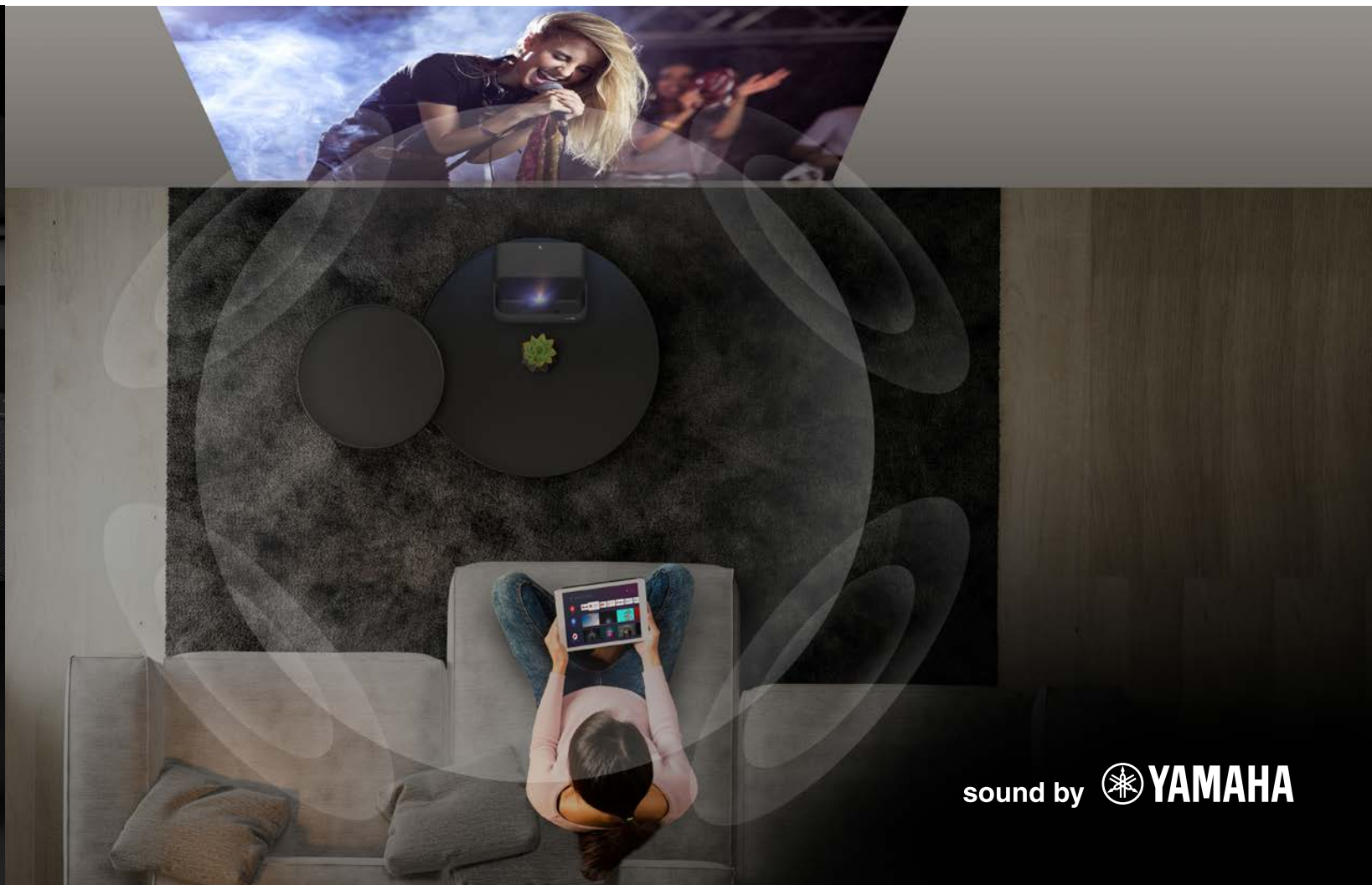

sound by  **YAMAHA**

## Watch, Play And Do More On Your Projector

Combining the best of both worlds, the EpiqVision Ultra EH-LS300B comes equipped with Google Play and Epson Online Meetings App. While the Google Play lets you access your favourite apps and games on your projector, Epson Online Meetings App allows you to handle group calls, online meetings and conferences without needing any extra software.

Watch, play and work whenever and wherever you want.

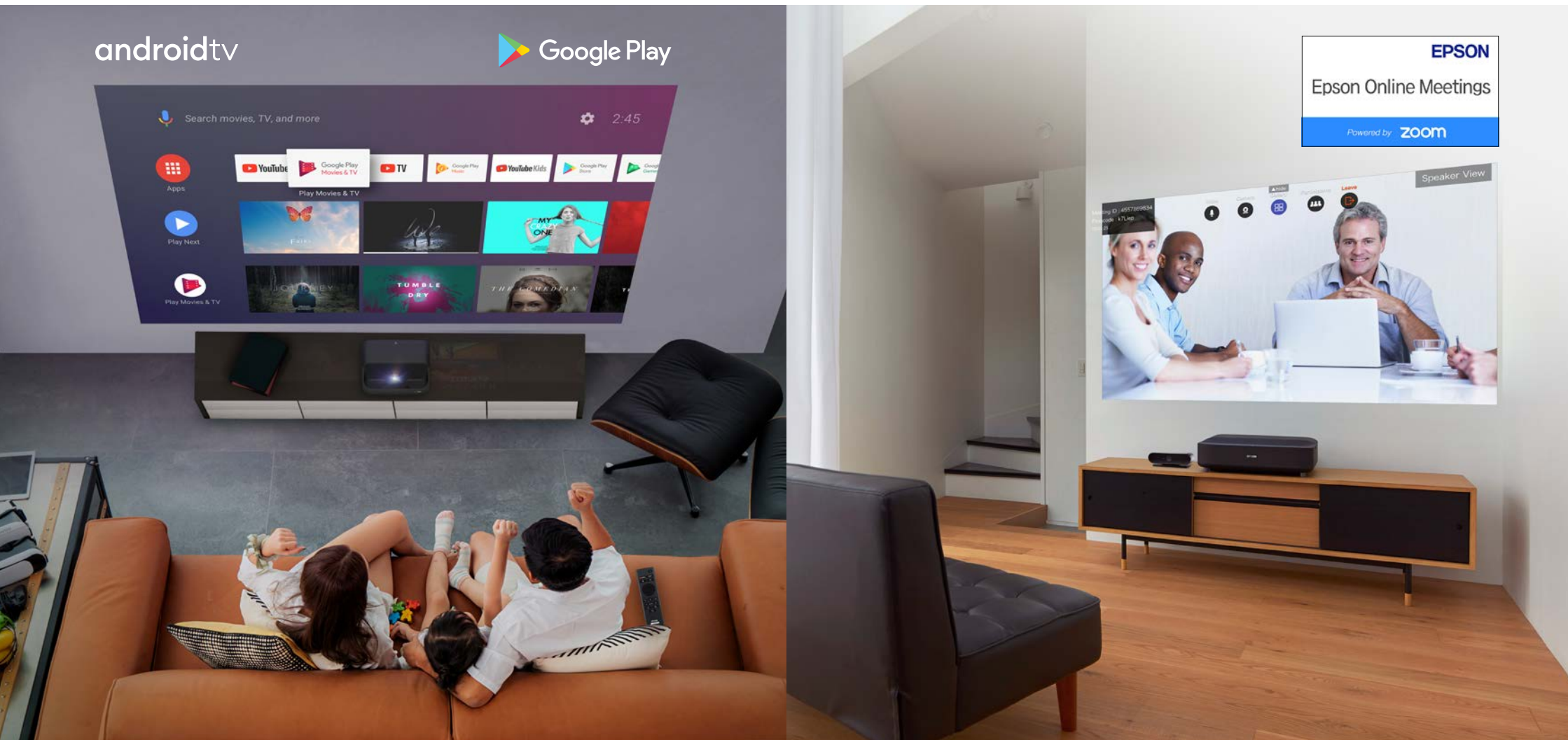



### Voice control

Google voice assistant-ready, control your viewing easily via voice commands. Now you can enjoy movies or plan your day, and even control your home from the comfort of the sofa.

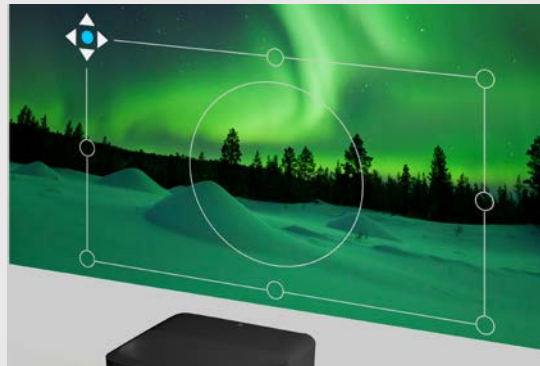

### Fuss-free set up

Enjoy easy set up using the built-in 8 point corner adjustment function, correcting the screen arc along with keystone and curved surface correction.



### Bluetooth speaker mode

Simply connect your smart devices via Bluetooth to the EpiqVision Ultra EH-LS300B and begin playing rich sounds with a quick click on the remote.





### Laser light motion sensor

The motion sensor is a safety feature that automatically turns off the laser light source when your child gets too close to the projector's light source, making the EpiqVision Ultra Laser Projection TV safe to use.



### Cast

You can cast the contents of apps on your smartphone or tablet to the EpiqVision Ultra EH-LS300B.



### More than 10 years of entertainment

With 20,000 hours of laser light source life and a 12,000-hour filter maintenance cycle, you can now enjoy more than 10 years of entertainment<sup>1</sup> on your EpiqVision Ultra EH-LS300B.



<sup>1</sup> 10 years calculated based on 5 hours usage per day.



## All-In-One Wide Range of Connectivity Options

Wave goodbye to complex cable management with the EpiqVision Ultra EH-LS300B. With wide connectivity for your external devices such as sound bars and Blu-ray player, you can simply link them up via the available HDMI ports with captivating larger than life images.

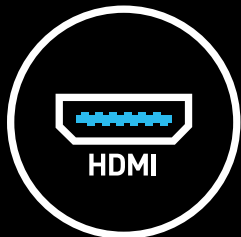

HDMI



Built-in  
Chromecast

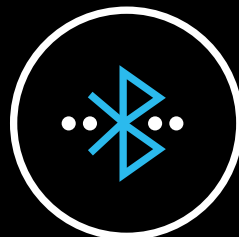

Bluetooth Audio  
Connectivity



Smart Device  
Wireless

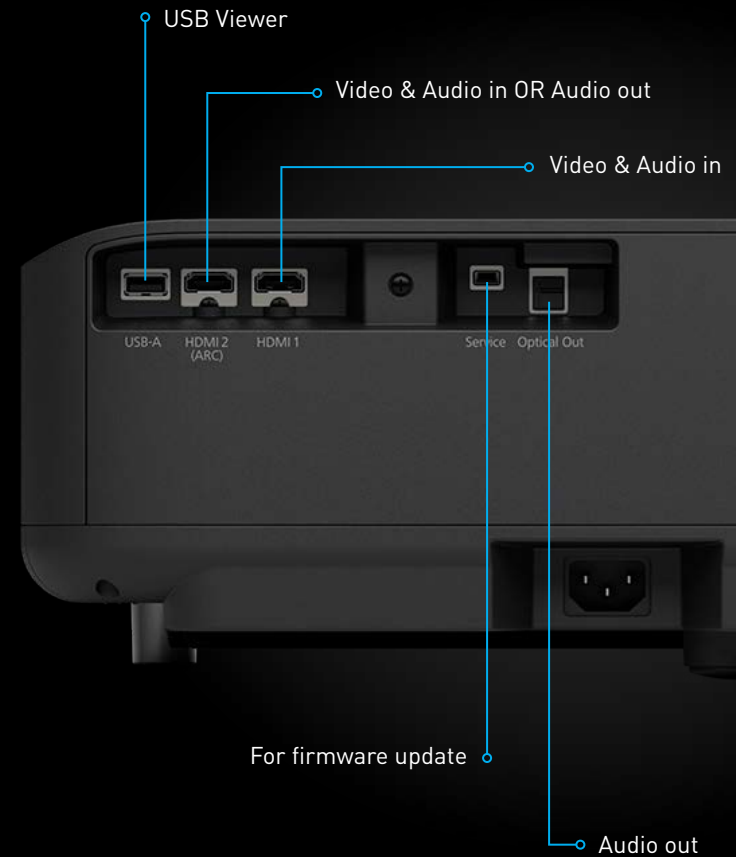

 <b>PRODUCT MODEL</b>			<b>EpiqVision Ultra EH-LS300B</b>
 <b>PROJECTION TECHNOLOGY</b>			RGB liquid crystal shutter projection system (3LCD)
 <b>SPECIFICATIONS OF MAIN PARTS</b>			
<b>LCD</b>	SIZE		0.61 inch (C <sup>2</sup> Fine)
	NATIVE RESOLUTION		Full HD (1080p)
<b>PROJECTION LENS</b>	TYPE		No optical zoom / Focus: manual
	F-NUMBER		1.6
	FOCAL LENGTH		3.7 mm
	THROW RATIO		0.26
	ASPECT RATIO		16:9
<b>LIGHT SOURCE</b>	TYPE		Laser diode
	LIFE (NORMAL / EXTENDED)		20,000 hours
 <b>SCREEN SIZE (PROJECTED DISTANCE)</b>			61" to 120" [34.9 cm to 70 cm]
 <b>BRIGHTNESS</b>	WHITE LIGHT OUTPUT (NORMAL / ECO)		3,600 lm / 1,800 lm
	COLOR LIGHT OUTPUT		3,600 lm
 <b>DYNAMIC CONTRAST RATIO</b>			Over 2,500,000:1
 <b>INTERNAL SPEAKER(S)</b>	SOUND OUTPUT		YAMAHA 2.1ch with enclosure 5W Speaker x 2, 10W Woofer x 1
 <b>GEOMETRIC CORRECTION</b>	KEystone		8 point arc correction
	PROJECTION ORIENTATION		Desktop
 <b>CONNECTIVITY</b>	DIGITAL INPUT	HDMI	2 (SMF, HDMI2=ARC)
	AUDIO OUT		Yes (Bluetooth / optical out)
	USB I/O	TYPE A	1 (For USB storage, RJ45, camera, mic, HID)
		MINI-B	1 (For firmware update)
	WIRELESS LAN	BUILT-IN	Yes (Smart media player function)
 <b>DIMENSIONS (D X W X H)</b>	EXCLUDING FEET		400 X 467 X 133 mm
 <b>POWER CONSUMPTION</b>	220 – 240V (NORMAL / STANDBY / ECO)		278W / 2.0W / 0.5W
 <b>FAN NOISE</b>	DECIBEL (NORMAL / MEDIUM / ECO)		37dB / 29dB / 23dB
 <b>WEIGHT</b>			Approx. 7.2 Kg

## WHAT'S IN THE BOX

- Quick Start Guide
- Owner's Manual CD ROM
- Safety and Support Guide CD ROM
- Remote Control with 2xAAA battery
- 1.8m Power Cable
- Warranty Card

©2020 Epson Singapore Pte Ltd. All Rights Reserved. Reproduction in part or in whole, without the written permission from Epson, is strictly prohibited.

EPSON and EXCEED YOUR VISION are registered trademarks of Seiko Epson Corporation.

All other product names and other company names used herein are for identification purposes only and are the trademarks or registered trademarks of their respective owners.

Epson disclaims any and all rights in those marks. Projected images shown herein are simulations. The actual product design and contents may vary. Specifications are subject to change without notice and may vary between countries. Please check with local Epson offices for more information.

Apple, iPad and iPhone are trademarks of Apple Inc., registered in the U.S. and other countries. App Store is a service mark of Apple Inc.

Android is a trademark of Google Inc.

Google Play and the Google Play logo are trademarks of Google LLC.

Information correct at time of printing.  
Printed December 2020

**EPSON**  
EXCEED YOUR VISION